

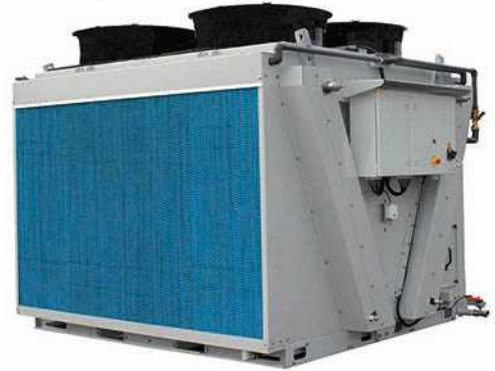

**BALTIMORE  
AIRCOIL COMPANY**



## **TVFC-RC Adiabatic Cooler Recirculation Mode**

### **SOFTWARE INSTRUCTIONS**

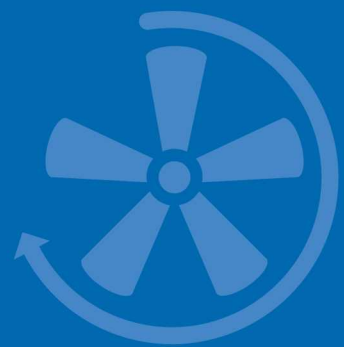
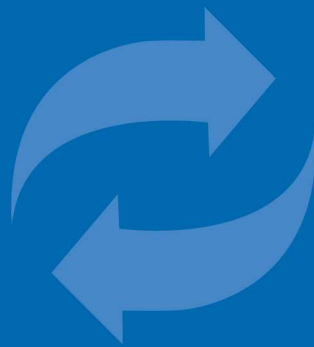



# Table of contents

## SOFTWARE INSTRUCTIONS

<b>1</b>	<b>Scope</b>	<b>3</b>
	Recirculation execution	3
<b>2</b>	<b>Control Logic</b>	<b>4</b>
<b>3</b>	<b>Programmable logic controller</b>	<b>6</b>
	Programmable Logic Controller (PLC)	6
	Display and operations	6
<b>4</b>	<b>Software</b>	<b>8</b>
	Menu overview	8
	Main Loop Menu (P)	9
	User Menu (E)	10
	Working Time Menu (T)	14
	Inputs Outputs Menu (I)	15
	Clock Menu (K)	16
	Logger Menu (H)	16
	System Information (S)	17
	Maintenance Menu (M)	17
<b>5</b>	<b>Alarms and Warnings overview</b>	<b>19</b>
	Alarms overview	19
<b>6</b>	<b>BMS Communication</b>	<b>21</b>
	Available communication protocols and communication cards	21
<b>7</b>	<b>Further Assistance &amp; Information</b>	<b>23</b>
	More information	23
	The service expert for BAC equipment	23

This manual applies to units configured in Recirculation mode operating on BAC software version V2.0.15B or later, in recirculation mode.

## Recirculation execution

The TVFC is a V-shaped dry cooler equipped with **adiabatic pre-coolers (1)** that cool the warm **process fluid (2)** by sensible heat transfer. **Water flows (3)** evenly over evaporative cooling pads located in front of the **dry finned coil (4)**. With the **make up (9)** situated on top of the pads, adiabatic precooling of the air can also be guaranteed when the pump is not in operation. **Axial (5) fans** draw **air (6)** through the pads where a portion of the water evaporates and cools down the saturated air. This increases the cooling capacity of the incoming air for cooling the **process fluid (7)** inside the coil. The **recirculation system (8)** can further reduce the total water consumption.

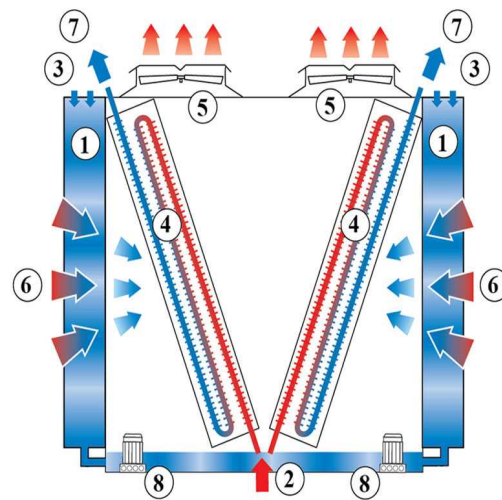

The controller controls the fan speed based on the actual fluid outlet temperature and the standard or free-cooling set point, ensuring a minimum electrical consumption and noise level. The PLC will operate as described in the flow chart that follows.

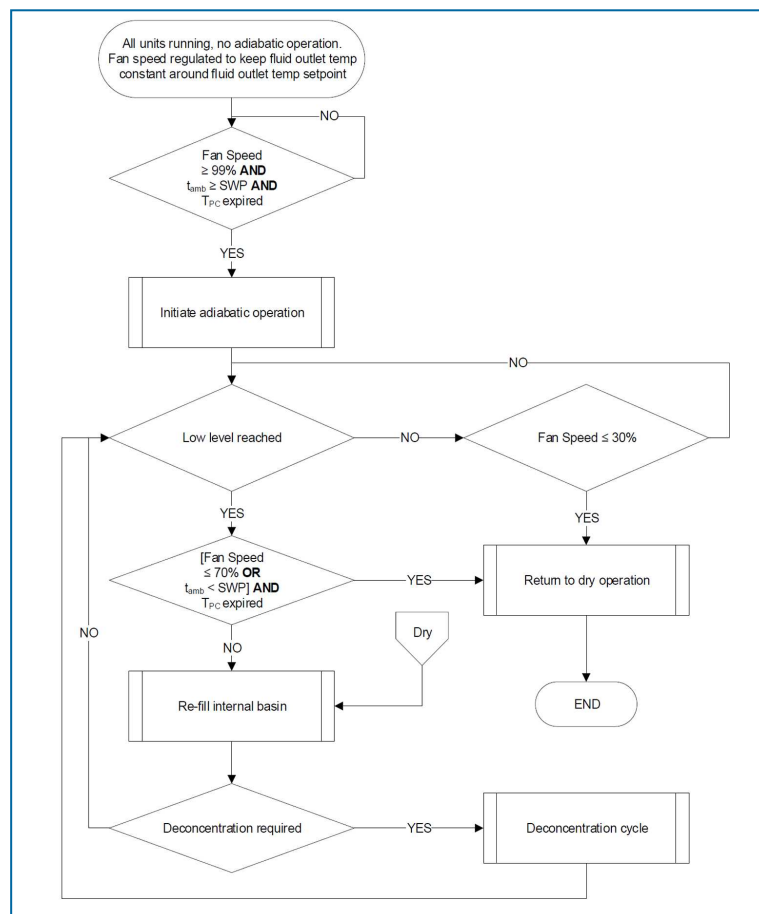

SWP: ambient temperature switch point

Tamb: ambient dry bulb temperature

Tpc: pre-cooler timer to avoid hunting in adiabatic activation/deactivation (default 5 min - adjustable)

The standard set-point, the free-cooling set-point and the ambient temperature switch-point are adjustable via the User Menu. The controller continuously measures the fluid outlet temperature via a temperature sensor installed in the fluid out pipe and the ambient temperature via a temperature sensor that is factory installed on the unit.



### CAUTION

Changing the controller's parameters may result in an undesired operation of the unit such as a hunting phenomenon, premature activation of pre-cooling (hence increased water consumption) or in late pre-cooling activation resulting in condenser pressure exceeding the design pressure.

## Programmable Logic Controller (PLC)

The PLC with built-in display:





## Display and operations

The controller display contains the screen and six operation keys.

The screen allows eight lines of text. The screen title and the screen reference are always on the top line.

Use the operation keys to navigate between the different menus and screens.

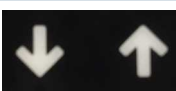
	<b>Alarm key</b>	Display the alarm menu.
	<b>Menu key</b>	Display the main menu screen.

	<b>Back key</b>	Revert to the previous step or menu.
	<b>Arrow keys</b>	Navigate between the different screens and menus.
	<b>Enter key</b>	Select the marked menu or parameter or enable the change of a parameter.



## Menu overview

Menu	Screen reference	Function
Main loop	P	Readout: <ul style="list-style-type: none"><li>- The unit status (ON/OFF)</li><li>- The fluid outlet and ambient temperature</li><li>- The fan speed</li><li>- The pre-cooler status</li></ul>
User	E	Set: <ul style="list-style-type: none"><li>- Run authorisation / local ON/OFF</li><li>- Standard and free-cooling set-point</li><li>- PI parameters</li><li>- Ambient temperature switch point for Adiabatic pre-cooling</li><li>- Adiabatic pre-cooler delay</li><li>- Adiabatic pre-cooler cleaning cycle</li><li>- Night quiet mode</li><li>- Time delay on alarm messages</li><li>- BMS communication settings</li></ul> The standard password for the User Menu is "1234".
Manufacturer	C	This menu is password protected and is not accessible to unauthorized personnel.
Working time	T	Readout the operating hours for the fans and adiabatic pre-cooling.
Inputs/outputs:	I	Readout the input and output status.
Clock	K	Set the correct time and date.
Logger	H	Readout the alarm and warning history.
System info	S	Readout the software and bios version.
Maintenance	M	Set the inputs and outputs manually for test purposes. The standard password for the Maintenance menu is "9876".



# Main Loop Menu (P)



The screens in the Main Loop Menu are read-only and cannot be edited.

## Screen P01

```

00:00:00 01/20/2020 P01
BACH1607697 01 Ad:0
Setpoint 00.0 °C
Tout 00.0 °C
Tamb 00.0 °C
Fan speed 000.0 %
OFF
  
```

Main screen with general information:

- The current time and date.
- The unit serial number and pLAN address: “Ad: 0”.
- “Setpoint”: the active setpoint for the fluid outlet temperature.
- “Tout”: the measured fluid outlet temperature.
- “Tamb”: the measured ambient temperature.
- “Fan speed”: the current fan speed.
- The unit status: “ON” or “OFF”.

### Note

*Unit status ON implies that the unit is ready to automatically respond to any heat rejection requirement, even in case the fans are temporarily deactivated due to the absence of a heat load.*

## Screen P03

```

T Tout 000.0 °C
T Tamb 000.0 °C
Control signal 000.0 %
Local En/Dis OFF
BUS En/Dis OFF
  
```

Overview of all inputs:

- “Tout”: the measured fluid outlet temperature.
- “Tamb”: the measured ambient temperature.
- “Control signal”: the calculated fan speed reference.
- “Local En/Dis”: the status of the remote start/stop (dry contact between terminals Y4:1-Y4:4).
- “BUS En/Dis”: the status of the BMS controlled variable “Run authorization” (refer to screen E02).

## Screen P05

```

Pre-cooling P05
Program state
0: Dry op./wait AD OF.
Tpc 00000 ---
Tcwv 00000 ---
Td 00000 ---
Tp 00000 ---
Deconc. counter 00
  
```

Adiabatic pre-cooling status: readout the status of the different timers and the deconcentration counter:

- “Tpc”: pre-cooling timer, delays the activation and deactivation of the adiabatic pre-cooling.
- “Tcwv”: city water valve timer: extends the city water supply after the pump has started.
- “Td”: drain valve timer, delays emptying of the sump.
- “Tp”: pump timer, protects the pump against running dry.
- “Deconc. Counter”: counts the number of sump refills.

## Screen P10-P51

```

P10-P51 EC fan No.2 P10
Offline Addr:002
Current speed 0000rpm
Max speed 00006 rpm
Power 00000W
Current 00000 mA
  
```

EC fan information screens:

- The fan status: “**Online**” or “**Offline**” and fan address: “**Addr: 002**”.
- “**Current speed**”: the actual fan speed.
- “**Max speed**”: the maximum allowable fan speed.
- “**Power**”: the actual power of the EC fan.
- “**Current**”: Indication of the internal current measured by the EC fan. In most cases this value is a DC current which is typically around 1.42 times bigger as the actual current, but for specific type of EC fans the AC current could be displayed. For exact evaluation of the fan current please measure the current on the terminal strip using an Amperage meter.

### Note

*In case an EC fan shows the status “Offline”, check the power supply to the fan and the Modbus communication wiring to the fan.*

## User Menu (E)



The screens in the User Menu are editable. The standard password is “1234”.

### Screen E01

```

Language E01
Language
French
Site name
BACH1607697 01
  
```

- “**Language**”: set the controller language to English, French, Dutch, Spanish or German.
- “**Site name**”: enter the unit serial number or the site name.

### Screen E02

```

Setpoints E02
Run authorisation OFF
Setpoints
Standard 30.0°C
Free cooling 10.0°C
  
```

- “**Run authorization**”: activate or deactivate the unit. This variable can either be set directly in this screen or via a BMS variable (see section 6: BMS communication).
- “**Standard setpoint**”: the default setpoint for the fluid outlet temperature.
- “**Free cooling setpoint**”: the setpoint for the fluid outlet temperature when the unit operates in free cooling mode. Switch over to free cooling mode via a BMS controlled variable or via the dry contact between terminals Y4:2-Y4:4.

### Example

*The controller controls the fan speed based on the actual fluid outlet temperature and the standard setpoint when the dry contact between terminals Y4:2-Y4:4 is open.  
When the dry contact between terminals Y4:2-Y4:4 is closed, the controller controls the fan speed based on the actual fluid outlet temperature and the free cooling setpoint.*

## Screen E03

```

PI control E03
Prop. Band : 010.0°C
Integr. Time : 060s
  
```

PI-parameters: these parameters determine the unit's reaction speed to changes in fluid outlet temperature.

- **“Prop. Band”**: set the value for the proportional band of the PI controller.
- **“Integr. Time”**: set the value for the integration time of the PI controller.



### CAUTION

Changing the PI-Parameters may result in a hunting phenomenon.

#### Note

*Make the unit react faster to changes in fluid outlet temperature by decreasing the proportional band and the integration time, or make the unit react slower by increasing the proportional band and integration time.*

## Screen E04

```

Cleaning cycle E04
PAD cleaning:
Active
Interval : 007days
Duration : 120 min
start between 14H00
and 18H00
  
```

Cleaning cycle for the adiabatic pre-coolers:

- **“PAD cleaning”**: allows you to enable or disable the cleaning cycle function.
- **“Interval”**: set the period (the number of days the adiabatic pre-cooling has not functioned) after which the cleaning cycle must activate.
- **“Duration”**: set the duration for the pre-cooler cleaning cycle.
- Set the time interval for the start of the cleaning cycle.

#### Example

*The pre-cooler cleaning cycle activates the pre-coolers during 120 minutes when the unit has not operated adiabatically for a period of 7 days. The cleaning cycle starts between 14h00 and 18h00.*

#### Note

*The controller automatically disables the cleaning cycle when the ambient temperature is below 4°C.*

## Screens E07-E08-E09

```

AD switchpoints E07
Setpoint : 25.0°C
Fan speed ON : 059%
Fan speed OFF : 070%
Fan speed OFF lim.: 030%
(De)activation delay
pre-clr(Tpc) : 0300sec
  
```

```

AD switchpoints E08
Time extension
make-up: TCUU : 0060sec
Sump refill
timer: TP : 5940sec
  
```

```

AD switch points E09
Sump drain
delay: TD : 03600s
Deconcentration after
03refills
Flow det. delay : 005s
(299s to disable)
  
```

Adiabatic pre-cooler temperature and fan speed switchpoints and timers:

- **“Setpoint”**: the temperature switchpoint for the activation of the adiabatic pre-cooling.
- **“Fan speed ON”** and **“Fan speed OFF”**: the fan speed switchpoints for the activation and deactivation of the adiabatic pre-cooling.
- **“Fan speed OFF lim.”**: the fan speed switchpoint for the immediate deactivation of the adiabatic pre-cooling.
- **“(De) activation delay pre-cooler Tpc”**: the time delay for the activation and deactivation of the adiabatic pre-cooling.

- “**Time extension make-up TCWV**”: timer to extend the city water supply after the pump has started.
- “**Sump refill timer Tp**”: time delay to prevent the pump from running dry. If the water level in the sump has not reached high level when Tp expires, AL050 Warning Pump activates.
- “**Sump drain delay Td**”: timer, which delays the emptying of the sump.
- “**Deconcentration after ... refills**”: the number of refill cycles before the deconcentration subroutine activates.
- “**Flow det. delay**”: in case the flow switch detects no flow from the pump, the controller triggers AL005 “Alarm flow detection”.

**Example**

- The unit initiates adiabatic operation when the ambient temperature > 25.0°C **AND** the fan speed > 99%, after a 300 second delay (Tpc).  
 In order to initiate adiabatic operation, the unit closes the drain valve and opens the city water supply valve in order to fill the sump. Once the sump is full, the pump starts.  
 The city water supply valve closes after a 60 second delay (T\_cwv).  
 - The unit returns to dry operation:  
 a) immediately when the fan speed < 30%.  
 b) after a 300 second delay (Tpc) when the ambient temperature < 24,9°C and low level reached **OR** the fan speed < 70% and low level reached.  
 When the unit returns to dry operation, the pump stops and the drain valve opens after a 3600 seconds delay (TD).  
 - When the unit detects low water level in the sump during adiabatic operation, the refill internal basin subroutine opens the city water valve.  
 In case the water level in the sump does not reach high level before the sump refill timer TP expires, the pump stops and the controller triggers “AL050 Warning pump”.  
 - The deconcentration subroutine activates after three refill cycles.  
 During the deconcentration cycle, the drain valve opens and it stays open until the water level in the sump reaches low level.

**Screens E10-E11-E13**

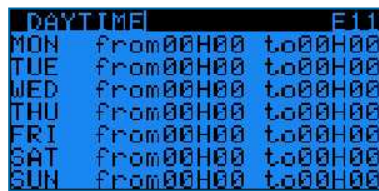
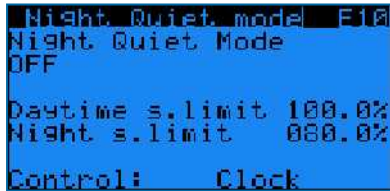

Night quiet mode: predefine fan speed limits for both day and night time.

- Enable/Disable the Night quiet mode and choose the maximum allowed fan speed during day and night on screen E10:
  - “**Night quiet mode**”: “**ON**” or “**OFF**”: enable or disable the Night quiet mode.
  - “**Daytime speed limit**” and “**Night time speed limit**”: set the maximum allowed fan speed during day and night time.
  - “**Control**”: choose the activation mode: either via a BMS controlled variable (“**via BMS**”) or via a predefined time daytime schedule in screen E11 (“**Clock**”).
  - “**Daytime clock**” Set up a time schedule for the daytime speed limit in screen E11: Monday to Sunday, start time to end time.



Outside of this time schedule, the night time speed limit will apply.

- “**Via BMS**”: Use parameter “**Night quiet mode day/night time speed limit via BMS**” to switch between daytime speed limit and night time speed limit (Refer to the communication tables in Chapter 6).
- Set specific adiabatic pre-cooler switchpoints for Night quiet mode operation in screen E12:
  - “**AD switchpnt.**”: specific temperature switchpoint for the activation of the adiabatic pre-coolers when the night time speed limit is active.

**Example**

The Night quiet mode is enabled, with a daytime speed limit of 80% and a night time speed limit of 50%.

**During daytime:**

- The pre-cooling will activate when the ambient temperature > 25.0°C **AND** the fan speed > 79.2% (= 99% x 80%) after a 300 second delay (Tpc).
- The unit will return to dry operation after a 300 seconds delay (Tpc) when the ambient temperature < 24.9°C **OR** the fan speed > 56% (= 70% x 80%) after a 30 second delay.

**During night time:**

- The pre-cooling will activate when the ambient temperature > 15.0 °C **AND** the fan speed > 49.5% (= 99% x 50%) after a 300 second delay (Tpc).
- The unit will return to dry operation after a 300 seconds delay (Tpc) when the ambient temperature < 14.9 °C **OR** the fan speed < 35% (= 70% x 50%) after a 30 second delay.

**Screen E14**



Adiabatic pre-cooling deactivation function:

- “**Pre-cooler deact.**”: enable or disable the pre-cooler deactivation function.
- Set the period and the time frame during which the unit deactivates the adiabatic pre-cooling.

**Example**

When the pre-cooling deactivation function is active, the adiabatic pre-cooling cannot activate between 13:00 and 15:00 o'clock from 15/07 to 15/09.

**Screen E17**



Choose the communication protocol: Modbus RS485, Modbus IP, Carel RS485, LON, BacNet IP or BacNet MSTP. Set the communication speed and network address, when applicable. See section 6: BMS communication.

**Screen E18**

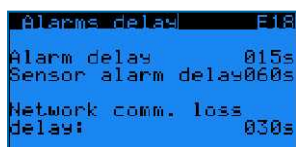

Alarm detection delays:

- “**Alarm delay**”: time delay for EC fan alarms and warnings.
- “**Sensor alarm delay**”: time delay for alarms from the fluid outlet temperature and ambient temperature sensor.
- “**Network comm. Loss delay**”: time delay for the loss of pLAN communication between units (not applicable for stand-alone operation).

**Note**

The network communication loss delay is not applicable to stand alone operation.

## Screens E19-E20

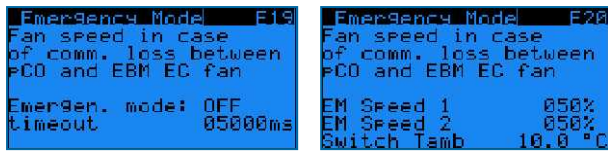

EC fan emergency mode management:

Enable the EC fan emergency mode to select a fixed fan speed for when the Modbus communication between the controller and the EC fans fails.

In case the EC fan emergency mode is disabled, the fans will continue to operate at the latest known fan speed when the Modbus communication between the controller and the EC fans fails.

- **“Emergen. mode”**: “ON” or “OFF”: enable or disable the EC fan emergency mode.
- **“Timeout”**: time delay before the EC fan emergency mode activates.
- **“EM speed 1”**: the emergency speed reference in case the ambient temperature  $\geq$  the ambient temperature switchpoint.
- **“EM speed 2”**: the emergency speed reference in case the ambient temperature  $<$  the ambient temperature switchpoint.
- **“Switch Tamb”**: the ambient temperature switchpoint.

### Example

*When the EC fan emergency mode is enabled, EM speed 1 is set to 100%, EM speed 2 is set to 50% and Switch Tamb is set to 15°C, the EC fans will start running at a fixed speed of 100% in case the Modbus communication between the controller and the EC fans fails when the ambient temperature is 20°C.*

*In case, the Modbus communication between the controller and the EC fans fails when the ambient temperature is 10°C, the EC fans will start running at a fixed speed of 50%.*

## Screen E21

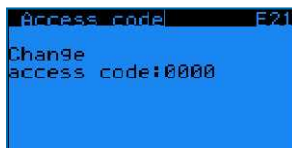

Set your own access code for the User Menu.

## Working Time Menu (T)



The screens in the Working Time Menu are read only and cannot be edited.

## Screen T01



Read the operating time for the EC fans and for the adiabatic pre-cooling, displayed in hours.

## Screen T04

```

Operating time T04
Dry op.      000000H
Make-up     000000H
  
```

Read the operating time for the EC fans, the pump, the make-up valve and the dry operating time displayed in hours.

## Inputs Outputs Menu (I)



The screens in the Inputs/Outputs Menu are read only and cannot be edited.

### Screens I01-I02

```

Inputs/Outputs T01
U1:T°C Tout    0000.0 °C
U2:T°C Tgen    0000.0 °C

Inputs/Outputs T02
U3:T°C Tamb    0000.0 °C
  
```

Read the analog inputs on the controller:

- “**U1: T°C Tout**”: the current fluid outlet temperature.
- “**U2: T°C Tgen**”: not used.
- “**U3: T°C Tamb**”: the current ambient temperature.

### Screen I03

```

Inputs/Outputs T03
U4-DI:Flow switch  ■
ID4-DI:Pump fault  ■
ID5-DI:Free Cooling ■
ID1 :On-Off        ■
U5 :Float switch   ■
O:open - ■:closed
  
```

Read the status of the digital inputs on the controller (open/closed):

- “**U4-DI: Flow switch**”: flow switch status (O: no flow / C: flow).
- “**ID4-DI: Pump fault**”: Pump override function (O: disabled / C: enabled).
- “**ID5-DI: Free cooling**”: status of the free cooling mode (dry contact between terminals Y4:2-Y4:4).
- “**ID1: On-Off**”: status of the remote start/stop command (dry contact between terminals Y4:1-Y4:4).
- “**U5: Float switch**”: water level in the sump (O: high level, C: low level).

### Screen I04

```

Inputs/Outputs T04
NO8:Alarm(s)      □
NO7:Warning(s)    □
NO3:Make-up       □
NO2:Drain         □
NO5:Pump          □
NO6:Operational   □
O:open - ■:closed
  
```

Read the status of the digital outputs on the controller (open/closed).

- “**NO8: Alarm(s)**”: closed contact means that there are one or more alarms active.
- “**NO7: Warning(s)**”: a closed contact means that there are one or more warnings active.

- “**NO3: Make-up**”: a closed contact means that the city water valve is open.
- “**NO2: Drain**”: a closed contact means that the drain valve is closed.
- “**NO5: Pump**”: a closed contact means that the pump is running.
- “**NO6: Operational**”: run indication, a closed contact means that the fans are running.

### Screen I05



Read the analog outputs on the controller:

- “**Y3: N.U**”: not used.
- “**Y4: Fan speed**”: a 0-10 Volt control signal, which corresponds to the actual fan speed.  
(0 V = 0%, 10 V = 100%)

## Clock Menu (K)



The screen in the Clock Menu is editable.

### Screen K01

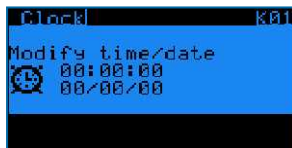

Set the correct time and date. Time format: HH:MM:SS and date format: DD/MM/YY.  
The software automatically adjusts to Daylight Saving Time.

## Logger Menu (H)



The screens in the Logger Menu are read only and cannot be edited.

### Screen H01



Read the history of past alarms.

The log shows the alarm message and the time the alarm occurred.



# System Information (S)



The screens in System Information are read only and cannot be edited.

## Screen S01

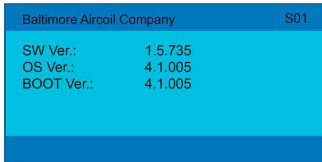

"SW Ver.": Current software version installed

"OS Ver.": Operating system version

"BOOT Ver.": Current boot version

# Maintenance Menu (M)

## Screen M01



Program a sensor offset ("Corr. :") to correct the temperature readings for the fluid outlet temperature sensor ("Outlet (U1)") and the ambient temperature sensor ("Tamb (U3)").

The general outlet temperature sensor is not used in stand-alone operation.

## Screen M02

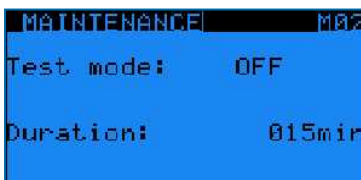

Activate the test mode, which allows to manually set analog and digital outputs and control the EC fans.

- "Test mode": activate or deactivate the test mode.
- "Duration": time delay after which the test mode automatically deactivates.

### Note

1. Duration set to 999 min keeps the test mode ON indefinitely
2. When the test mode is set to OFF, screens M03 to M07 are invisible.

### Note

When the test mode ends, the controller will show a pop up screen saying "Test mode ended please reboot controller". Reboot the controller to assure that all inputs and outputs are cleared before resuming automatic operation.

### Screen M04

```

Dig. out. override M04
Make-up (N03): □
Drain (N02): □
Pump (N05): □
Run indication(N06): □
Alarm (N08): □
Warning (N07): □
□: Open / ■: Closed
  
```

Manually set the digital outputs:

- **“Make-up”**: activate or deactivate the city water supply valve.
- **“Drain”**: activate or deactivate the drain valve.
- **“Pump”**: activate or deactivate the pump.
- **“Run indication”**: simulate the run indication.
- **“Alarm”**: simulate an alarm.
- **“Warning”**: simulate a warning.

### Screen M05

```

Test model M05
Output override
analog:
Y3:000.0 Volt
Y4:000.0 Volt
  
```

Manually set the analog outputs:

- **“Y3”**: not used for a unit with EC fan motors.
- **“Y4”**: simulate a 0-10 Volt output.

### Screen M06

```

Global fan test M06
Fan speed000.0%
Control type Global
  
```

Manually control the EC fans:

- **“Fan speed”**: 0% to 100%
- **“Control type”**: choose **“Global”** to operate all fans simultaneously at the same speed or choose **“1 by 1”** to set the speed for each fan individually via screen M07.

### Screen M07

```

Test indiv. fans M07
N°2 000.0% N°9 000.0%
N°3 000.0% N°10 000.0%
N°4 000.0% N°11 000.0%
N°5 000.0% N°12 000.0%
N°6 000.0% N°13 000.0%
N°7 000.0% N°14 000.0%
N°8 000.0% N°15 000.0%
  
```

Set the speed for each fan individually.

## Alarms overview

- Access the alarms by pressing the alarm button on the controller (triangle with exclamation mark).
- If a particular alarm is no longer present, the alarm message is automatically cleared and the general alarm (NO1) deactivates.
- To see the history of past alarms, check the logger menu.

**Note**

The Alarm status can be read out via dry contact on terminal Y3: 3/4/5 and the warning status on Y3: 1/2 in the control panel.

### Screen AL000

No alarm present.

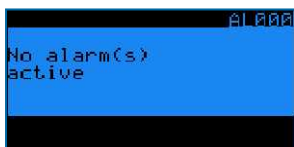

### Screen AL001



Fluid outlet temperature sensor (on input U1) is defective.

- Unit stops working.
- Alarm message AL001 on controller display + general alarm (NO1) activates.

### Screen AL003



Ambient air temperature sensor (on input U3) is defective.

- Unit remains operational in dry mode, adiabatic operation no longer possible.
- Alarm message AL003 on controller display + general alarm (NO1) activates.

## Screen AL005

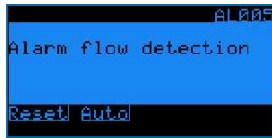

Alarm flow detection.

- The flow sensor detects no flow from the pump.
- The controller stops the pump + displays AL005 + general alarm (NO1) activates.

## Screens AL010-AL106



Alarms and warnings from the EC fans. Consult BAC factory for more information.

- Unit remains operational, but the defective fan stops working.

## Screen AL050



Warning pump









- The sump refill timer TP has expired and the water level in the sump has not yet reached high level.
- The controller stops the pump and displays AL050.





## Available communication protocols and communication cards

The following communication protocols are available: Carel RS485, Modbus RS485, Modbus TCP/IP, Bacnet IP, Bacnet MS/TP and LON. The table below shows the required communication card and software settings for each communication protocol.



Based on your selection, this manual will only contain the information you require.

Protocol	Communication card reference	Typical parameter settings in the controller	Interface file required?	Available settings
<b>CAREL RS485</b>			No	- Baudrate: 1200 to 19200 - Slave addresses: 1 to 207
<b>Modbus RS485</b>			No	- Baudrate: 1200 to 19200 - Parity: None, Even or Odd - Nbr. stop bits: 1 or 2 - Slave addresses: 1 to 207
<b>Modbus TCP/IP</b>			No	
<b>Bacnet IP</b>			No	

Protocol	Communication card reference	Typical parameter settings in the controller	Interface file required?	Available settings
Bacnet MS/TP			No	
LON			Yes (Xif and Nxe file)	



## More information

### REFERENCE LITERATURE

- Eurovent 9-5 (6) Recommended Code of Practice to keep your Cooling System efficient and safe. Eurovent/Cecomaf, 2002, 30p.
- Guide des Bonnes Pratiques, Legionella et Tours Aéroréfrigérantes. Ministères de l'Emploi et de la Solidarité, Ministère de l'Economie des Finances et de l'Industrie, Ministère de l'Environnement, Juin 2001, 54p.
- Voorkom Legionellose. Ministerie van de Vlaamse Gemeenschap. December 2002, 77p.
- Legionnaires' Disease. The Control of Legionella Bacteria in Water Systems. Health & Safety Commission. 2000, 62p.
- Hygienische Anforderungen an raumluftechnische Anlagen. VDI 6022.

### INTERESTING WEBSITES

Baltimore Aircoil Company	<a href="http://www.BaltimoreAircoil.com">www.BaltimoreAircoil.com</a>
BAC Service website	<a href="http://www.BACservice.eu">www.BACservice.eu</a>
Eurovent	<a href="http://www.eurovent-certification.com">www.eurovent-certification.com</a>
European Working Group on Legionella Infections (EWGLI)	<a href="http://EWGLI">EWGLI</a>
ASHRAE	<a href="http://www.ashrae.org">www.ashrae.org</a>
Uniclimate	<a href="http://www.uniclimate.fr">www.uniclimate.fr</a>
Association des Ingénieurs et techniciens en Climatique, Ventilation et Froid	<a href="http://www.aicvf.org">www.aicvf.org</a>
Health and Safety Executive	<a href="http://www.hse.gov.uk">www.hse.gov.uk</a>

### ORIGINAL DOCUMENTATION



This manual is originally made in English. Translations are provided for your convenience. In the event of discrepancies, the English original text shall prevail over the translation.

## The service expert for BAC equipment

We offer tailored services and solution for BAC cooling towers and equipment.

- Original spare parts and fill -for an efficient, safe and year round reliable operation.
- Service solutions - preventive maintenance, repairs, refurbishments, cleaning and disinfection for reliable trouble-free operation.
- Upgrades and new technologies - save up energy and improve maintenance by upgrading your system.
- Water treatment solutions - equipment for controlling corrosion scaling and proliferation of bacteria.

For more details, contact your local BAC representative for further information and specific assistance at [www.BACservice.eu](http://www.BACservice.eu)



A series of horizontal dotted lines spanning the width of the page, providing a template for handwritten notes or a list.





A series of horizontal dotted lines for writing, spanning the width of the page.



A series of horizontal dotted lines spanning the width of the page, providing a template for handwritten notes or a checklist.





A series of horizontal dotted lines for writing, spanning the width of the page.



A series of horizontal dotted lines spanning the width of the page, providing a template for writing or data entry.





A series of horizontal dotted lines for writing, spanning the width of the page.

COOLING TOWERS

---

CLOSED CIRCUIT COOLING TOWERS

---

ICE THERMAL STORAGE

---

EVAPORATIVE CONDENSERS

---

HYBRID PRODUCTS

---

PARTS, EQUIPMENTS & SERVICES

BLUE by nature  
GREEN at heart



[www.BaltimoreAircoil.com](http://www.BaltimoreAircoil.com)

[Europe@BaltimoreAircoil.com](mailto:Europe@BaltimoreAircoil.com)

Please refer to our website for local contact details.

Industriepark - Zone A, B-2220 Heist-op-den-Berg, Belgium

© Baltimore Aircoil International nv